

**DATA SHEET**

# SKY73089-11: 1200 – 1700 MHz High Gain and Linearity Diversity Downconversion Mixer

## Applications

- 2G/3G base station transceivers:
  - GSM/EDGE, CDMA, UMTS/WCDMA
- Land mobile radio
- High performance radio links

## Features

- Operating frequency range: 1200 to 1700 MHz
- IF frequency range: 50 to 500 MHz
- Conversion gain: 9.3 dB
- Input IP3: +26.8 dBm
- Output IP3: +36.1 dBm
- Noise Figure: 9.3 dB
- Integrated LO drivers
- Integrated low loss RF baluns
- High linearity IF amplifiers
- On-chip SPDT LO switch (greater than 40 dB LO-to-LO isolation)
- Small, MCM (36-pin, 6 x 6 mm) package (MSL3, 260 °C per JEDEC J-STD-020)



Skyworks Green™ products are compliant with all applicable legislation and are halogen-free. For additional information, refer to Skyworks Definition of Green™, document number SQ04-0074.

## Description

The SKY73089-11 is a fully integrated diversity mixer that includes Local Oscillator (LO) drivers, an LO switch, high linearity mixers, and large dynamic range Intermediate Frequency (IF) amplifiers. Low loss RF baluns have also been included to reduce design complications and lower system cost.

The SKY73089-11 features an input IP3 of +26.8 dBm and a Noise Figure (NF) of 9.3 dB, making the device an ideal solution for high dynamic range systems such as 2G/3G base station receivers. The LO switch provides more than 40 dB of isolation between LO inputs and supports the switching time required for GSM/EDGE base stations.

The SKY73089-11 is manufactured using a robust silicon BiCMOS process and has been designed for optimum long-term reliability. The SKY73089-11 diversity downconversion mixer is provided in a compact, 36-pin Multi-Chip Module (MCM). A functional block diagram is shown in Figure 1. The pin configuration and package are shown in Figure 2. Signal pin assignments and functional pin descriptions are provided in Table 1.

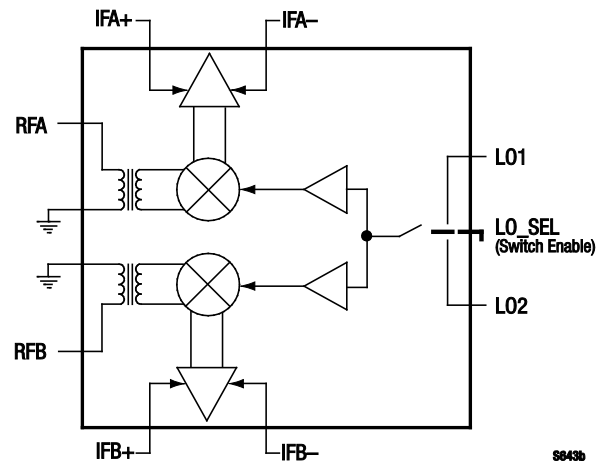

**Figure 1. SKY73089-11 Block Diagram**

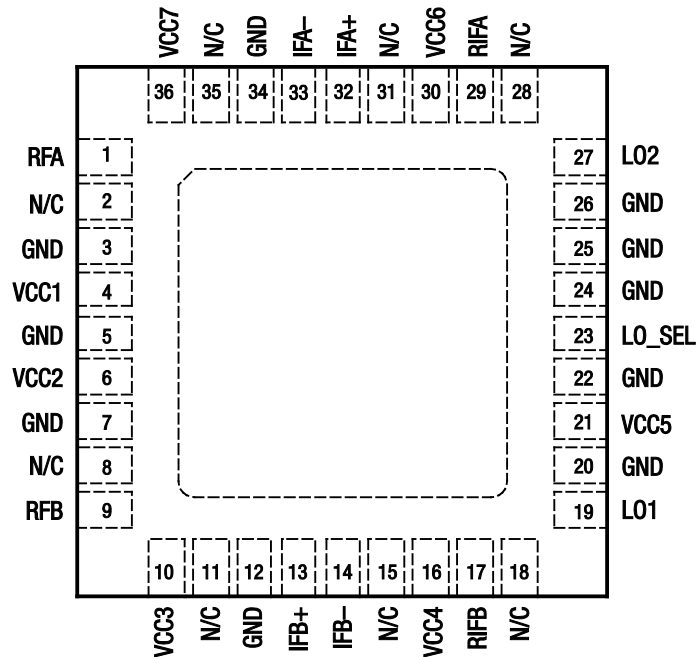

S646a

Figure 2. SKY73089-11 Pinout – 36-Pin MCM (Top View)

Table 1. SKY73089-11 Signal Descriptions

Pin #	Name	Description	Pin #	Name	Description
1	RFA	RF channel A input	19	LO1	Local oscillator #1 input
2	NC	No connect	20	GND	Ground
3	GND	Ground	21	VCC5	DC supply, +5 V
4	VCC1	DC supply, +5 V	22	GND	Ground
5	GND	Ground	23	LO_SEL	Local oscillator switch select
6	VCC2	DC supply, +5 V	24	GND	Ground
7	GND	Ground	25	GND	Ground
8	NC	No connect	26	GND	Ground
9	RFB	RF channel B input	27	LO2	Local oscillator #2 input
10	VCC3	DC supply, +5 V	28	NC	No connect
11	NC	No connect	29	RIFA	IF channel A bias control
12	GND	Ground	30	VCC6	DC supply, +5 V
13	IFB+	IF channel B positive output	31	NC	No connect
14	IFB-	IF channel B negative output	32	IFA+	IF channel A positive output
15	NC	No connect	33	IFA-	IF channel A negative output
16	VCC4	DC supply, +5 V	34	GND	Ground
17	RIFB	IF channel B bias control	35	NC	No connect
18	NC	No connect	36	VCC7	DC supply, +5 V

## Functional Description

The SKY73089-11 is a high gain diversity mixer, optimized for base station receiver applications. The device consists of two diversity channels, each consisting of a low loss RF balun, high linearity passive mixer, and a low noise IF amplifier.

LO amplifiers are also included that allow the SKY73089-11 to connect directly to the output of a Voltage Controlled Oscillator (VCO). This eliminates the extra gain stages needed by most discrete passive mixers. A Single Pole, Double Throw (SPDT) switch has been included to select between two different LO inputs for frequency hopping applications (i.e., GSM).

### RF Baluns and Passive Mixer

The RF baluns provide a single ended input, which can easily be matched to 50  $\Omega$  using a simple matching circuit. The RF baluns offer very low loss and excellent amplitude and phase balance.

The high linearity mixer is a passive, double balanced mixer that provides a very low insertion loss, and excellent 3<sup>rd</sup> Order Input Insertion Point (IIP3) and linearity performance.

Additionally, the balanced nature of the mixer provides for excellent port-to-port isolation.

### LO Buffers and SPDT LO Switch

The LO buffers allow the input power of the SKY73089-11 to be programmed in the range of -6 to +6 dBm. The LO section has been optimized for high-side LO injection. However, the LO can be driven over a wide frequency range with only slight degradation in performance.

A high isolation SPDT switch allows the SKY73089-11 to be used for frequency hopping applications. This switch provides greater than 60 dB of LO1 to LO2 isolation:

LO_SEL Logic:	State:
High	LO1 enabled
Low	LO2 enabled

For applications that do not require frequency hopping, LO\_SEL is fixed to one state and the appropriate LO input is used.

### IF Amplifier

The SKY73089-11 includes high dynamic range IF amplifiers that follow the passive mixers in the signal path. The outputs require a supply voltage connection using inductive chokes. These choke inductors should be high-Q and have the ability to handle 200 mA or greater.

A simple matching network allows the output ports to be matched to a balanced 200  $\Omega$  impedance. The IF amplifiers are optimized for IF frequencies between 50 and 500 MHz. The IF amplifiers can be operated outside of this range, but with a slight degradation in performance.

## Electrical and Mechanical Specifications

The absolute maximum ratings of the SKY73089-11 are provided in Table 2. The recommended operating conditions are specified in Table 3 and electrical specifications are provided in Table 4.

Spurious suppression measurements are provided in Table 5.

Typical performance characteristics of the SKY73089-11 are illustrated in Figures 3 through 29.

**Table 2. SKY73089-11 Absolute Maximum Ratings**

Parameter	Symbol	Minimum	Typical	Maximum	Units
Supply voltage, +5 V (VCC1 – VCC7)	VCC	4.5	5.0	5.5	V
Supply current	I <sub>CC</sub>		370	430	mA
RF input power	P <sub>RF</sub>			+20	dBm
LO input power	P <sub>LO</sub>		0	+20	dBm
Operating case temperature	T <sub>C</sub>	–40		+85	°C
Junction temperature	T <sub>J</sub>			+150	°C
Storage case temperature	T <sub>STG</sub>	–40		+125	°C

**Notes:** Exposure to maximum rating conditions for extended periods may reduce device reliability. There is no damage to device with only one parameter set at the limit and all other parameters set at or below their nominal value. Exceeding any of the limits listed here may result in permanent damage to the device.

Nominal thermal resistance (junction to center ground pad) is 5.1 °C/W.

---

**CAUTION:** Although this device is designed to be as robust as possible, Electrostatic Discharge (ESD) can damage this device. This device must be protected at all times from ESD. Static charges may easily produce potentials of several kilovolts on the human body or equipment, which can discharge without detection. Industry-standard ESD precautions should be used at all times.

---

**Table 3. SKY73089-11 Recommended Operating Conditions**

Parameter	Symbol	Minimum	Typical	Maximum	Units
RF frequency range	F <sub>RF</sub>	1200		1700	MHz
LO frequency range (Note 1)	F <sub>LO</sub>	1250		2150	MHz
IF frequency range	F <sub>IF</sub>	50		450	MHz
Supply voltage, +5 V (VCC1 – VCC7)	VCC	4.75	5.00	5.25	V
Supply current	I <sub>CC</sub>		370		mA
LO input power	P <sub>LO</sub>	–6	0	+6	dBm
LO select logic: high	LO_SELH	2.2			V
low	LO_SELL			0.8	V
Operating case temperature	T <sub>C</sub>	–40		+85	°C

**Note 1:** The SKY73089-11 has been optimized for high-side LO injection. However, the LO can be used outside of the specified frequency range with degraded performance.

**Table 4. SKY73089-11 Electrical Specifications (Note 1)****(Voltage Supply = +5 V, T<sub>c</sub> = +25 °C, L<sub>O</sub> = 0 dBm, RF Frequency = 1445 MHz, IF Frequency = 350 MHz, L<sub>O</sub> Frequency = 1795 MHz, Unless Otherwise Noted)**

Parameter	Symbol	Test Condition	Min	Typical	Max	Units
Conversion gain	G		8.6	9.3		dB
Conversion gain variation over temperature	G	-40 °C to +85 °C		±0.6		dB
Noise Figure	NF			9.3	11.0	dB
Noise Figure variation over temperature	NF	-40 °C to +85 °C		±0.8		dB
Noise Figure with a blocker signal	NF <sub>BLK</sub>	Blocking signal input power = +8 dBm			25	dB
Third order input intercept point	IIP3	F <sub>RF</sub> = 1445 and 1445.8 MHz, P <sub>RF</sub> = -10 dBm/each tone	+24.0	+26.8		dBm
Third order input intercept point variation over temperature	IIP3	-40 °C to +85 °C		±0.5		dB
Third order output intercept point	OIP3	F <sub>RF</sub> = 1445 and 1445.8 MHz, P <sub>RF</sub> = -10 dBm/each tone		+36.1		dBm
2L <sub>O</sub> – 2RF	2x2	P <sub>RF</sub> = -10 dBm		-71	-60	dBc
3L <sub>O</sub> – 3RF	3x3	P <sub>RF</sub> = -10 dBm		-83	-70	dBc
Input 1 dB compression point	IP1dB		+11.7	+13.9		dBm
Input 1 dB compression point variation over temperature	IP1dB	-40 °C to +85 °C		±0.6		dB
Output 1 dB compression point	OP1dB			+22.2		dBm
L <sub>O1</sub> to L <sub>O2</sub> isolation			40	49		dB
Channel-to-channel isolation			46	54		dB
RF to IF isolation			60	67		dB
LO leakage: 1xL <sub>O</sub> to RF port 2xL <sub>O</sub> to RF port 3xL <sub>O</sub> to RF port 4xL <sub>O</sub> to RF port 1xL <sub>O</sub> to IF port				-28 -22 -52 -68 -62	-25 -20 -32 -50 -30	dBm dBm dBm dBm dBm
L <sub>O</sub> _SEL input			-20	+150	+250	μA
L <sub>O</sub> switching time					1.0	μs
RF port input return loss	Z <sub>IN_RF</sub>	With external matching components	14			dB
L <sub>O</sub> port input return loss	Z <sub>IN_LO</sub>	With external matching components	14			dB
IF port input return loss	Z <sub>OUT_IF</sub>	With external matching components	14			dB

**Note 1:** Performance is guaranteed only under the conditions listed in this Table.

**Table 5. SKY73089-11 Spur Suppression Measurements, 3GPP Bands #11 and 21 (Note 1)**

Parameter	Symbol	Test Condition	Min	Typical	Max	Units
4RF-3LO	4X3	$P_{RF} = 0$ dBm, $F_{RF} = 1440$ MHz, IF spur frequency = 375 MHz		-98	-85	dBc
6RF-5LO	6X5	$P_{RF} = 0$ dBm, $F_{RF} = 1445$ MHz, IF spur frequency = 305 MHz		-112	-85	dBc
7RF-6LO	7X6	$P_{RF} = 0$ dBm, $F_{RF} = 1480$ MHz, IF spur frequency = 410 MHz		-122	-85	dBc
9RF-7LO	9X7	$P_{RF} = 0$ dBm, $F_{RF} = 1430$ MHz, IF spur frequency = 305 MHz		-119	-85	dBc
10RF-8LO	10X8	$P_{RF} = 0$ dBm, $F_{RF} = 1400$ MHz, IF spur frequency = 360 MHz  $P_{RF} = 0$ dBm, $F_{RF} = 1465$ MHz, IF spur frequency = 290 MHz		-114  -120	-85  -85	dBc

**Note 1:** Performance is guaranteed only under the conditions listed in this Table.

**Typical Performance Characteristics**

(Voltage Supply = +5 V, Tc = +25 °C, LO = 0 dBm, RF Frequency = 350 MHz, IF Frequency = 90 MHz, LO Frequency = 440 MHz, Unless Otherwise Noted)

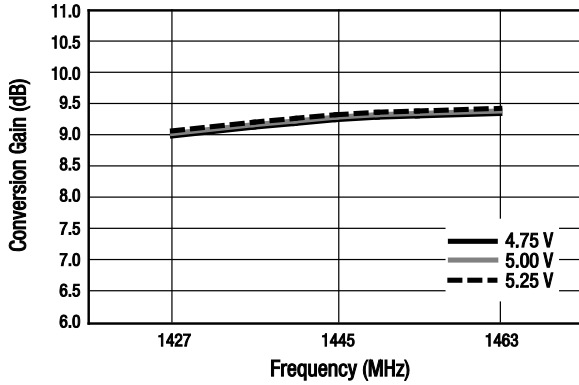

Figure 3. Channel A Gain Over Frequency and Supply Voltage

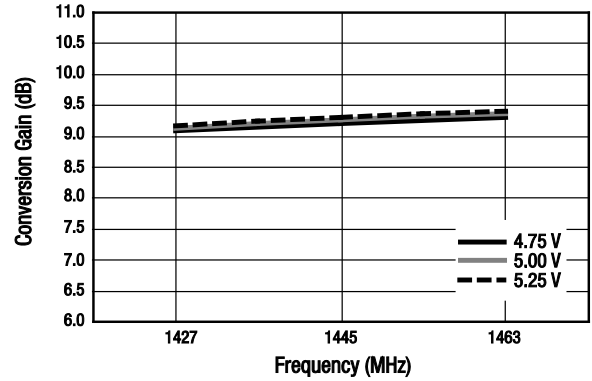

Figure 4. Channel B Gain Over Frequency and Supply Voltage

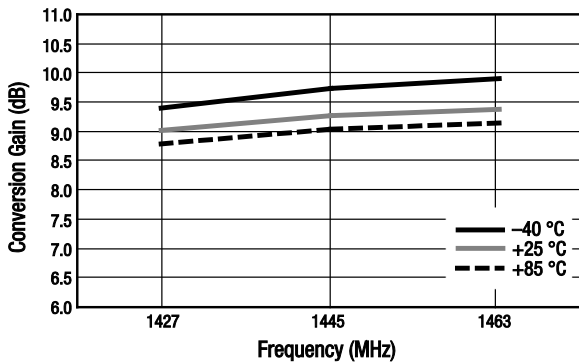

Figure 5. Channel A Gain Over Frequency and Temperature

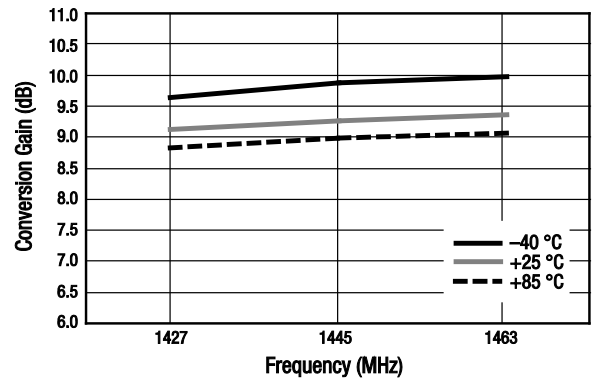

Figure 6. Channel B Gain Over Frequency and Temperature

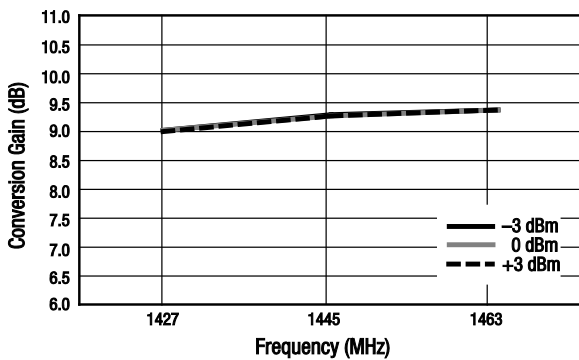

Figure 7. Channel A Gain Over Frequency and LO Power

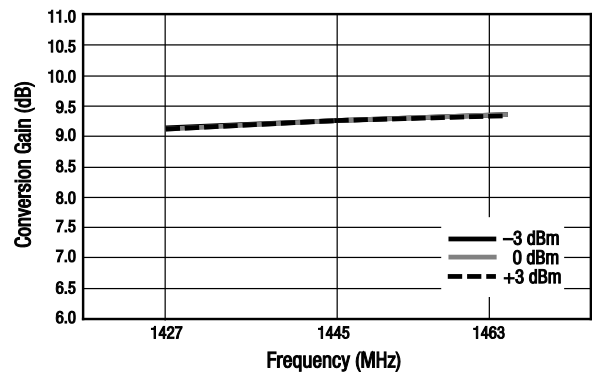

Figure 8. Channel B Gain Over Frequency and LO Power

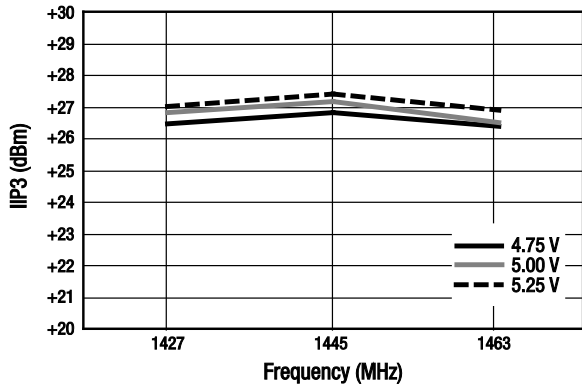

Figure 9. Channel A IIP3 Over Frequency and Supply Voltage

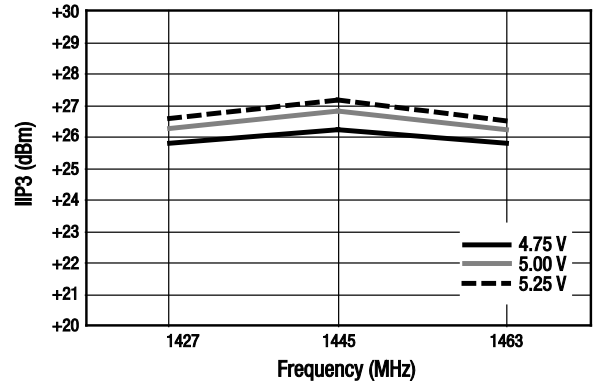

Figure 10. Channel B IIP3 Over Frequency and Supply Voltage

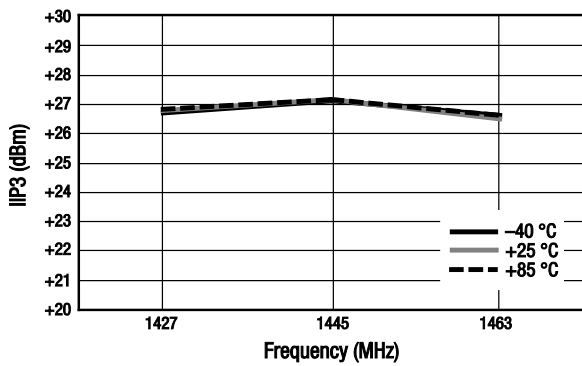

Figure 11. Channel A IIP3 Over Frequency and Temperature

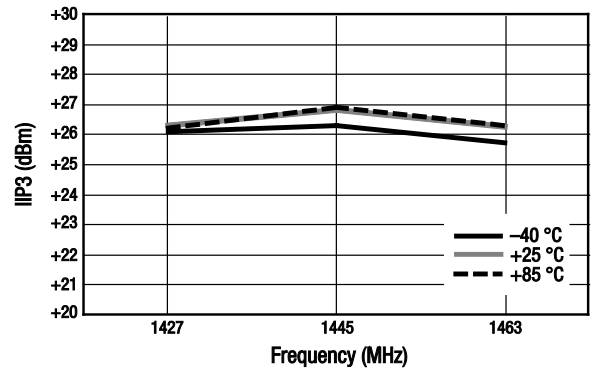

Figure 12. Channel B IIP3 Over Frequency and Temperature

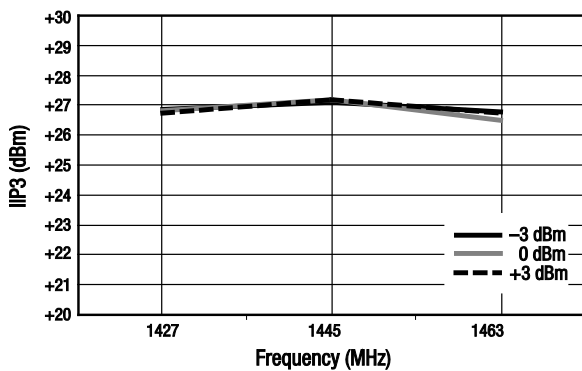

Figure 13. Channel A IIP3 Over Frequency and LO Power

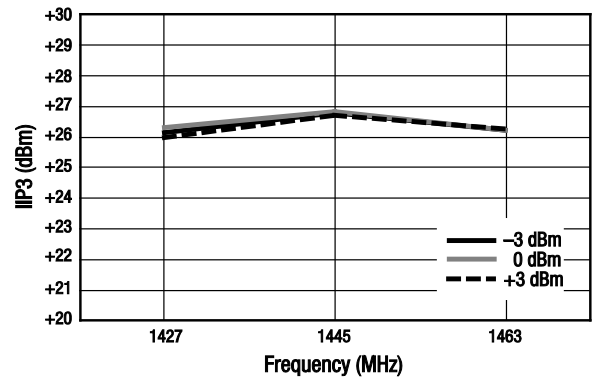

Figure 14. Channel B IIP3 Over Frequency and LO Power



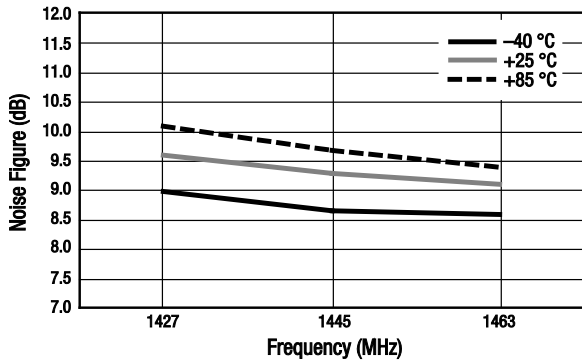

Figure 15. Channel A Noise Figure Over Frequency and Temperature

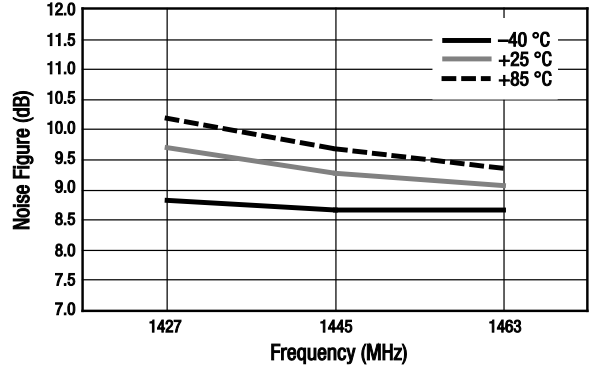

Figure 16. Channel B Noise Figure Over Frequency and Temperature

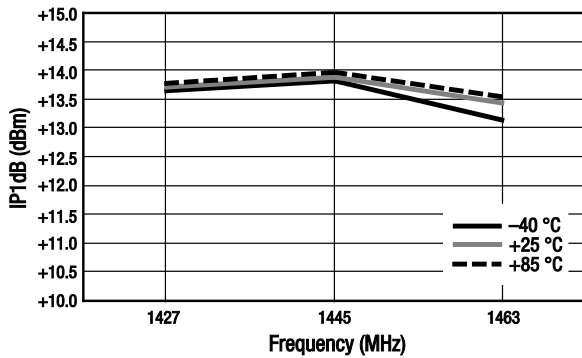

Figure 17. Channel A IP1dB Over Frequency and Temperature

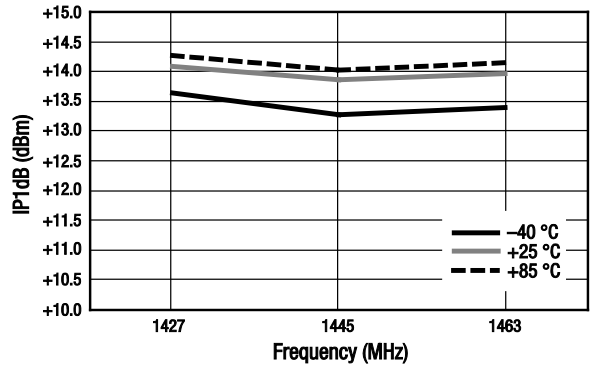

Figure 18. Channel B IP1dB Over Frequency and Temperature

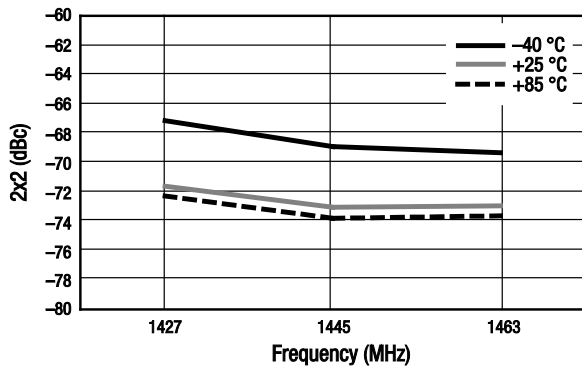

Figure 19. Channel A 2x2 Over Frequency and Temperature

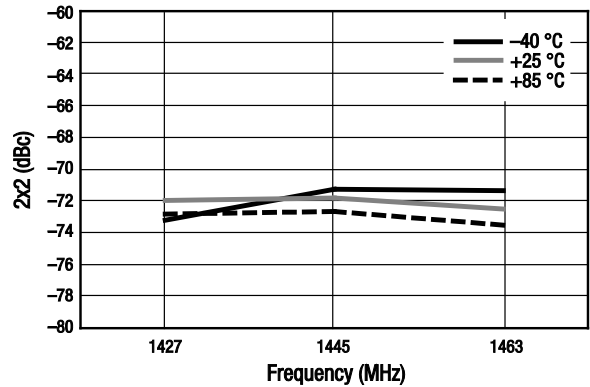

Figure 20. Channel B 2x2 Over Frequency and Temperature

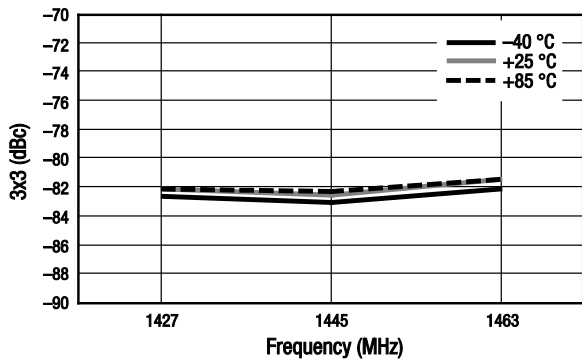

Figure 21. Channel A 3x3 Over Frequency and Temperature

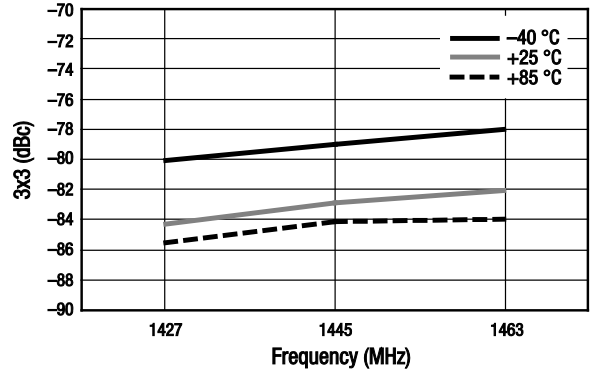

Figure 22. Channel B 3x3 Over Frequency and Temperature

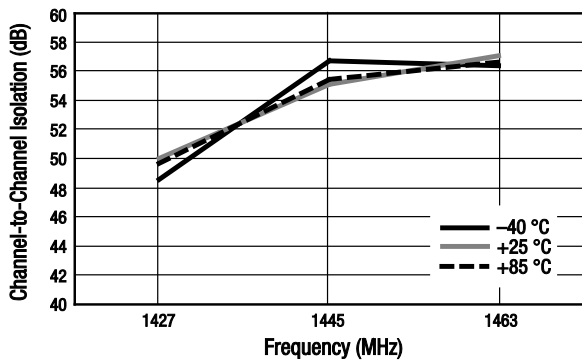

Figure 23. Channel-to-Channel Isolation Over Frequency and Temperature

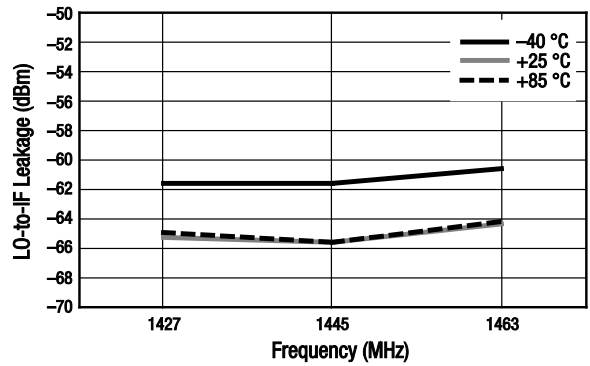

Figure 24. Channel A LO to IF Leakage Over Frequency and Temperature

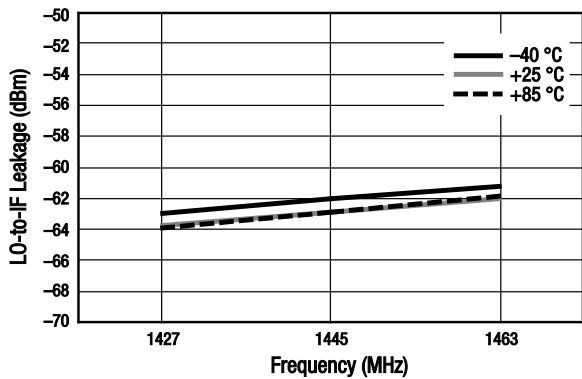

Figure 25. Channel B LO to IF Leakage Over Frequency and Temperature

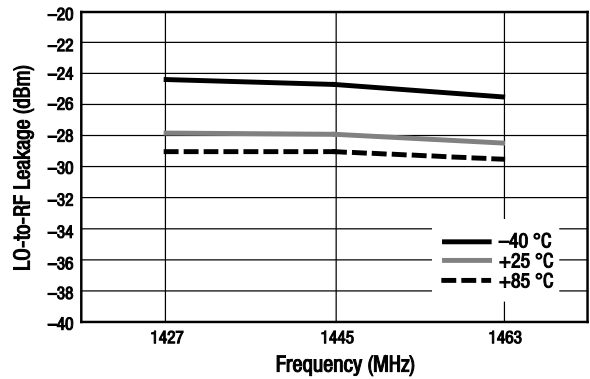

Figure 26. Channel A LO to RF Leakage Over Frequency and Temperature

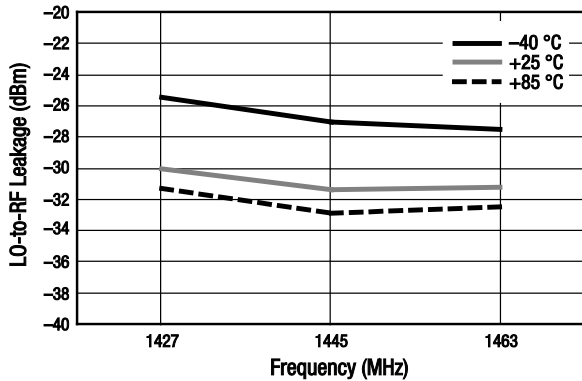

Figure 27. Channel B LO to RF Leakage Over Frequency and Temperature

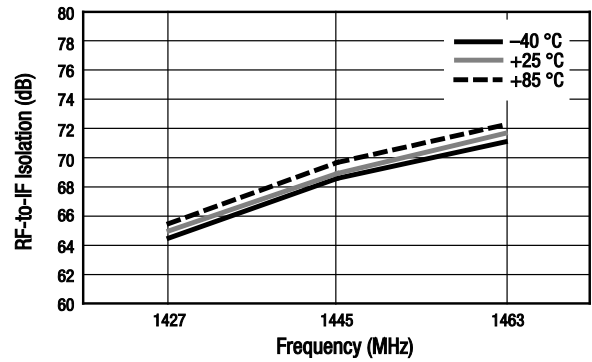

Figure 28. Channel A RF to IF Isolation Over Frequency and Temperature

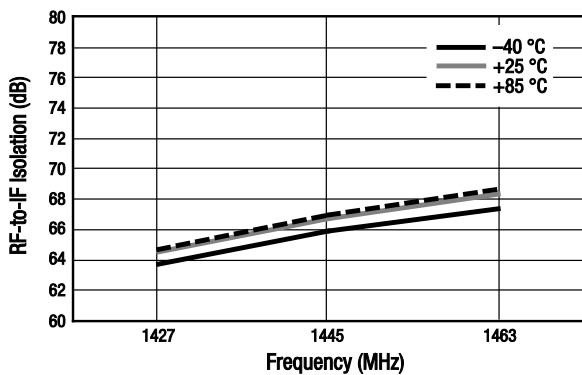

Figure 29. Channel B RF to IF Isolation Over Frequency and Temperature

## Evaluation Board Description

The SKY73089-11 Evaluation Board is used to test the performance of the SKY73089-11 downconversion mixer. An assembly drawing for the Evaluation Board is shown in Figure 30 and the layer detail is provided in Figure 31. A schematic diagram of the SKY73089-11 Evaluation Board is shown in Figure 32.

## Circuit Design Configurations

The following design considerations are general in nature and must be followed regardless of final use or configuration:

1. Paths to ground should be made as short as possible.
2. The ground pad of the SKY73089-11 has special electrical and thermal grounding requirements. This pad is the main thermal conduit for heat dissipation. Since the circuit board acts as the heat sink, it must shunt as much heat as possible from the device. Therefore, design the connection to the ground pad to dissipate the maximum wattage produced by the circuit board.

3. Skyworks recommends including external bypass capacitors on the VCC voltage inputs of the device.
4. Components L5, L6, L14, and L15 (see Figure 32) are high-Q low loss inductors. These inductors must be able to pass currents in excess of 200 mA DC.
5. Components R1 and R2 (see Figure 32) set the bias current for the IF amplifiers. Skyworks recommends that these resistors have a tolerance of  $\pm 1\%$  to optimize performance consistency of the SKY73089-11. These resistors are not required for the Evaluation Board to operate as specified in Tables 3 and 4.

## Package Dimensions

The PCB layout footprint for the SKY73089-11 is provided in Figure 33. Figure 34 shows the package dimensions for the 36-pin MCM and Figure 35 provides the tape and reel dimensions.

**Package and Handling Information**

Since the device package is sensitive to moisture absorption, it is baked and vacuum packed before shipping. Instructions on the shipping container label regarding exposure to moisture after the container seal is broken must be followed. Otherwise, problems related to moisture absorption may occur when the part is subjected to high temperature during solder assembly.

THE SKY73089-11 is rated to Moisture Sensitivity Level 3 (MSL3) at 260 °C. It can be used for lead or lead-free soldering. For

additional information, refer to the Skyworks Application Note, *PCB Design & SMT Assembly/Rework Guidelines for MCM-L Packages*, document number 101752.

Care must be taken when attaching this product, whether it is done manually or in a production solder reflow environment. Production quantities of this product are shipped in a standard tape and reel format.

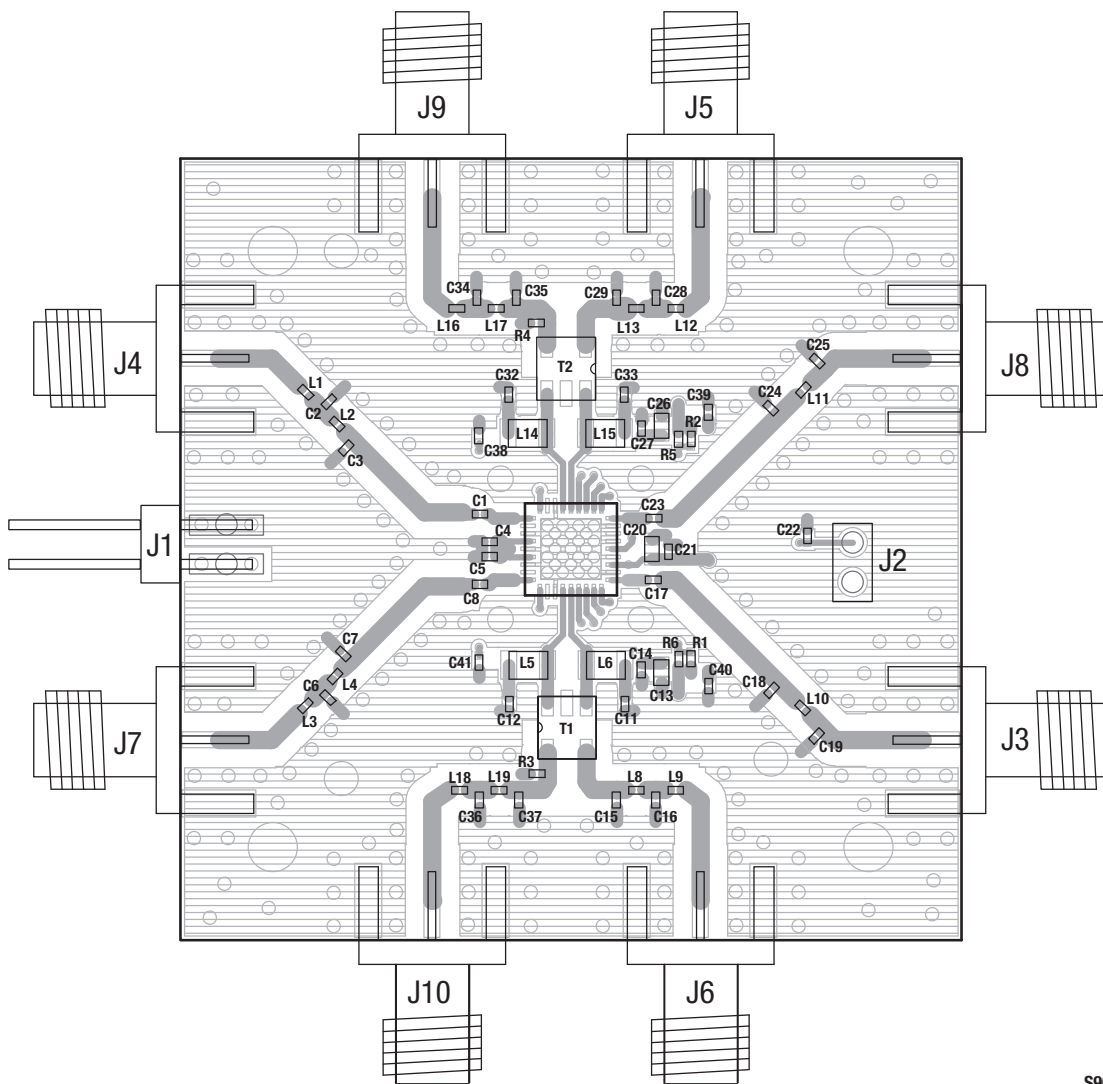

S905

**Figure 30. SKY73089-11 Evaluation Board Assembly Diagram**

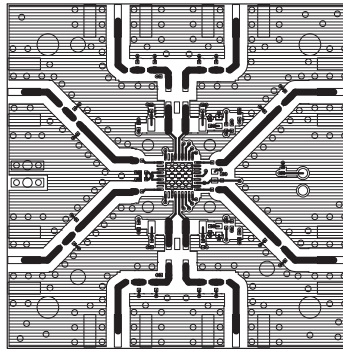

Layer 1: Top -- Metal

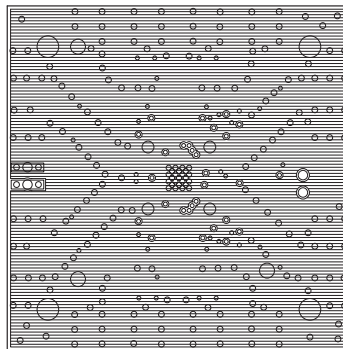

Layer 2: Ground

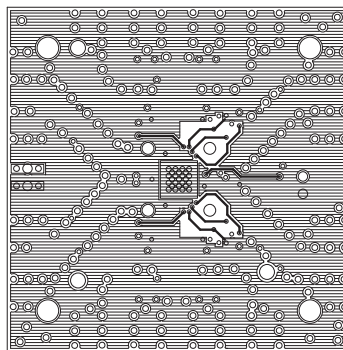

Layer 3: Power Plane

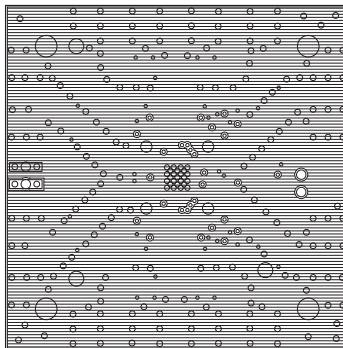

Layer 4: Solid Ground Plane

S904

**Figure 31. SKY73089-11 Evaluation Board Layer Detail**

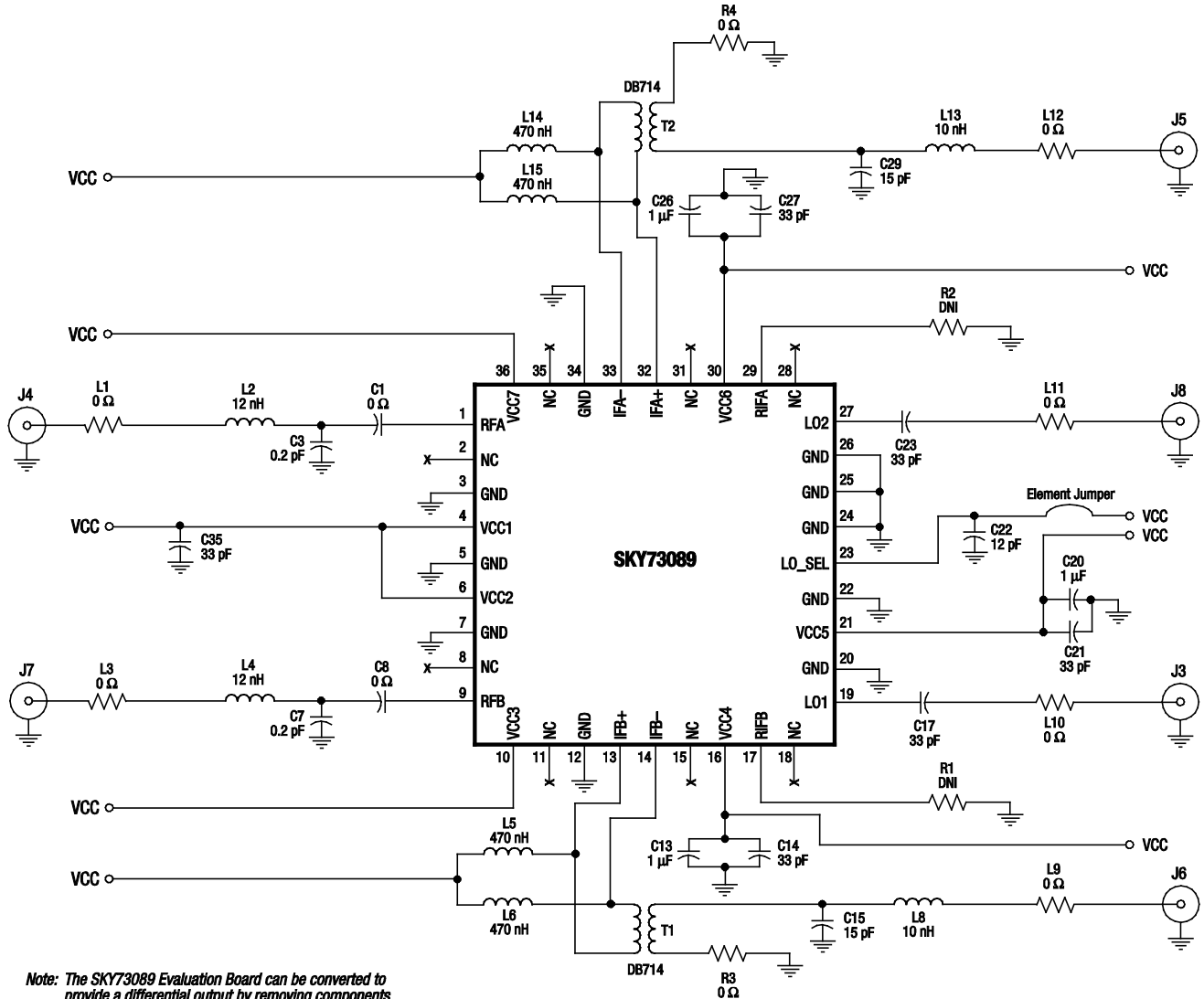

Note: The SKY73089 Evaluation Board can be converted to provide a differential output by removing components T1, T2, R3, and R4.

Some component labels may be different than the corresponding component symbol shown here. Component values, however, are accurate as of the date of this Data Sheet.

S1772

Figure 32. SKY73089-11 Evaluation Board Schematic

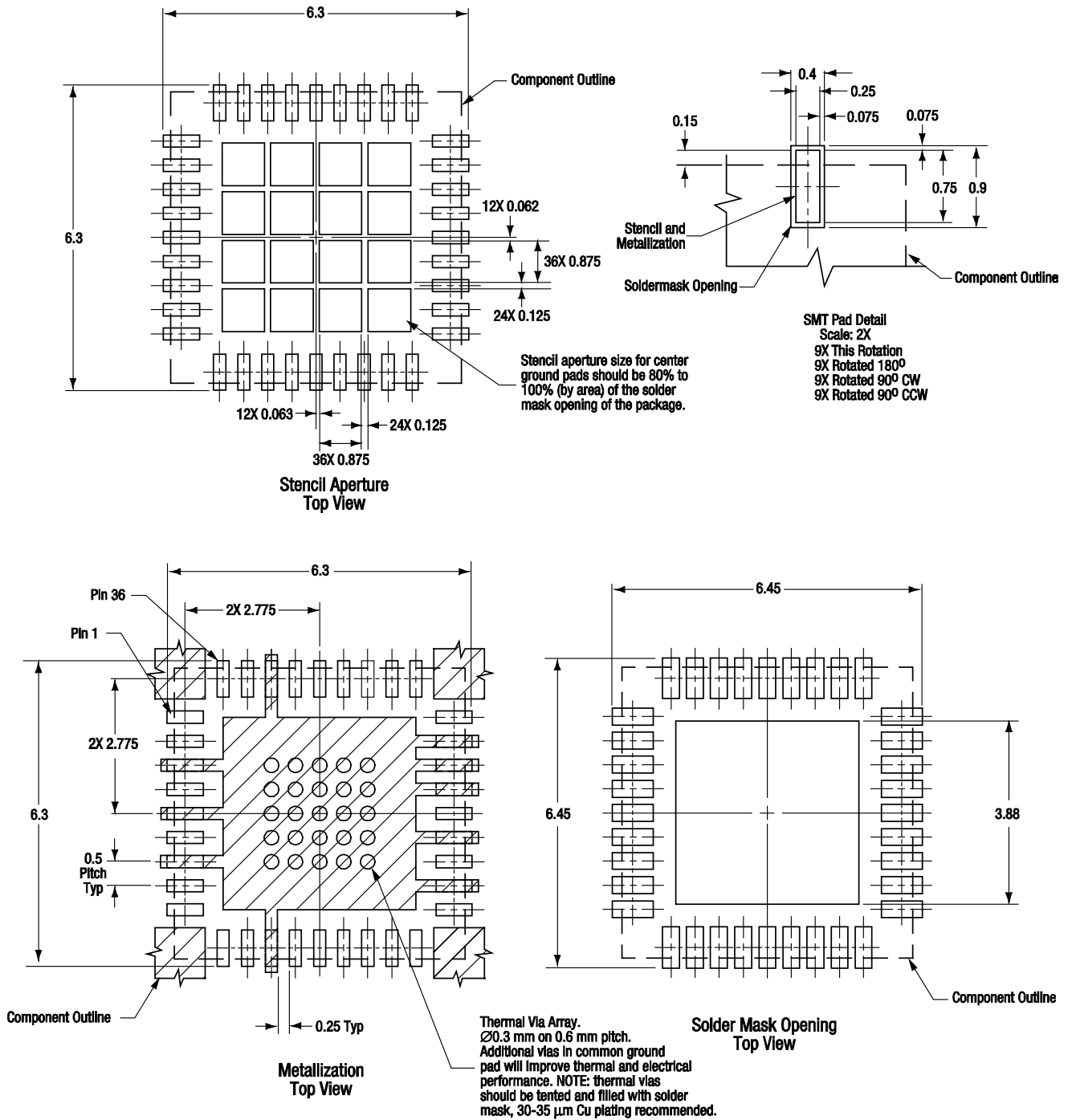

Note: The cross-hatched area represents the merger of the center ground pad +10 individual I/O ground pads. All I/O ground pads should have at least one via connected to internal ground planes for optimum electrical performance.

All measurements are in millimeters

S1125

Figure 33. PCB Layout Footprint for the SKY73089-11 6 x 6 mm MCM

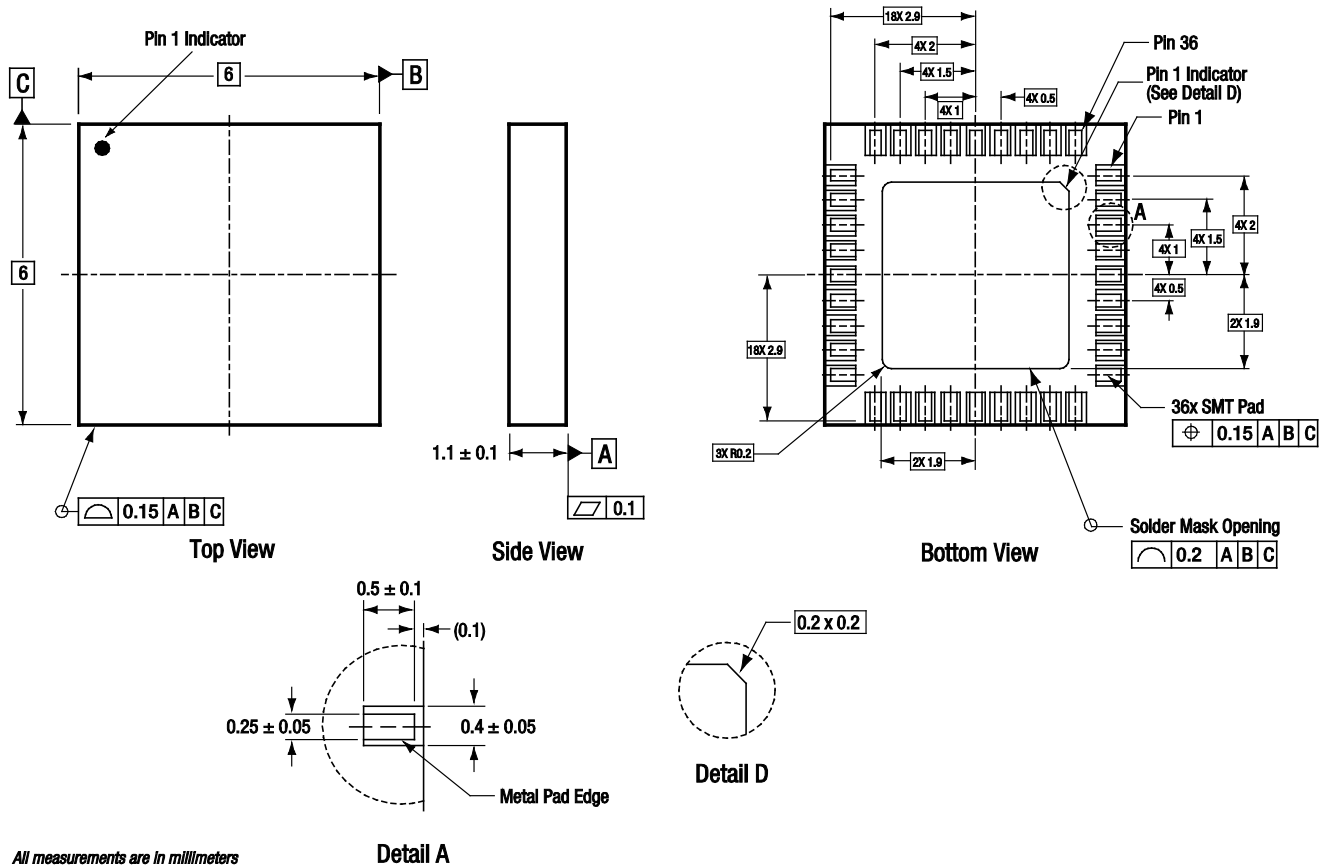

All measurements are in millimeters

Pads are solder mask defined on one edge and metal defined on three edges.

Dimensioning and tolerancing according to ASME Y14.5M-1994

S689\_A

Figure 34. SKY73089-11 36-Pin MCM Package Dimensions



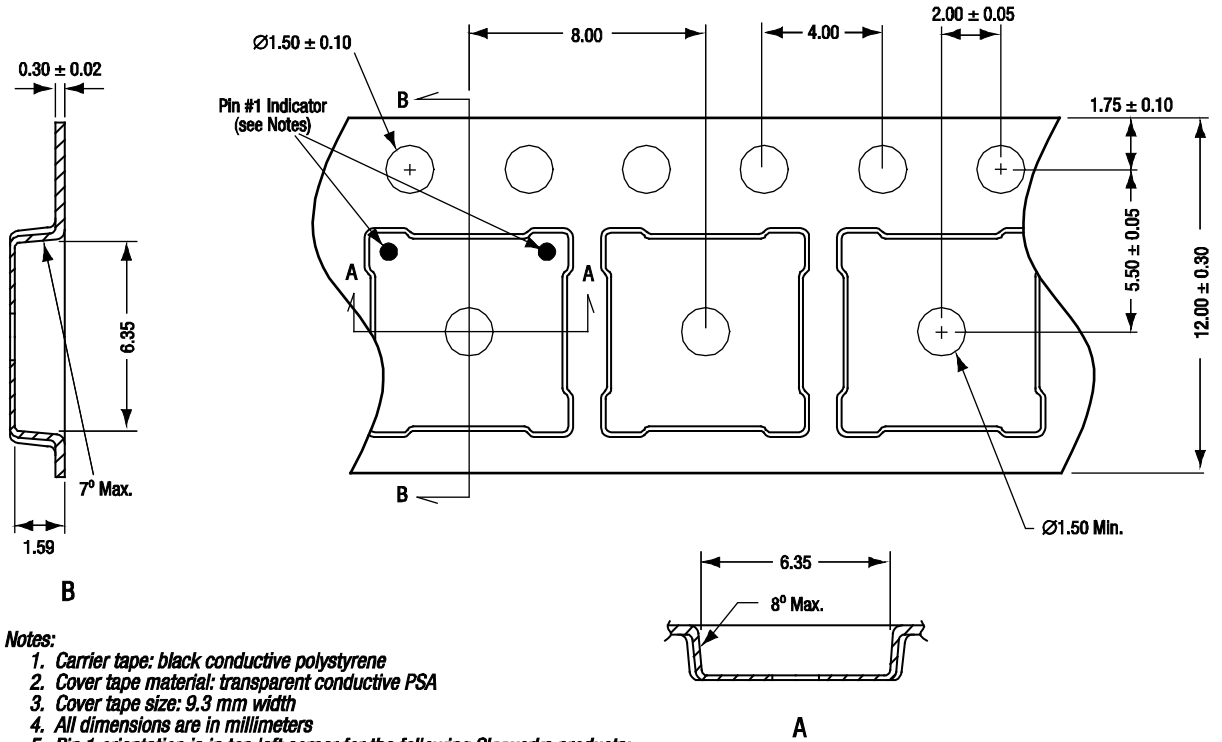

**Notes:**

1. Carrier tape: black conductive polystyrene
2. Cover tape material: transparent conductive PSA
3. Cover tape size: 9.3 mm width
4. All dimensions are in millimeters
5. Pin 1 orientation is in top left corner for the following Skyworks products:

SKY73022-21, -31  
SKY73023-21, -31

For all other 6 x 6 mm MCM/RFLGA products, pin 1 orientation is in top right corner.

S1183

**Figure 35. SKY73089-11 Tape and Reel Dimensions**

## Ordering Information

Model Name	Manufacturing Part Number	Evaluation Board Part Number
SKY73089-11 1200-1700 MHz Downconversion Mixer	SKY73089-11	TW17-D880

Copyright © 2009, 2010, 2012 Skyworks Solutions, Inc. All Rights Reserved.

Information in this document is provided in connection with Skyworks Solutions, Inc. ("Skyworks") products or services. These materials, including the information contained herein, are provided by Skyworks as a service to its customers and may be used for informational purposes only by the customer. Skyworks assumes no responsibility for errors or omissions in these materials or the information contained herein. Skyworks may change its documentation, products, services, specifications or product descriptions at any time, without notice. Skyworks makes no commitment to update the materials or information and shall have no responsibility whatsoever for conflicts, incompatibilities, or other difficulties arising from any future changes.

No license, whether express, implied, by estoppel or otherwise, is granted to any intellectual property rights by this document. Skyworks assumes no liability for any materials, products or information provided hereunder, including the sale, distribution, reproduction or use of Skyworks products, information or materials, except as may be provided in Skyworks Terms and Conditions of Sale.

THE MATERIALS, PRODUCTS AND INFORMATION ARE PROVIDED "AS IS" WITHOUT WARRANTY OF ANY KIND, WHETHER EXPRESS, IMPLIED, STATUTORY, OR OTHERWISE, INCLUDING FITNESS FOR A PARTICULAR PURPOSE OR USE, MERCHANTABILITY, PERFORMANCE, QUALITY OR NON-INFRINGEMENT OF ANY INTELLECTUAL PROPERTY RIGHT; ALL SUCH WARRANTIES ARE HEREBY EXPRESSLY DISCLAIMED. SKYWORKS DOES NOT WARRANT THE ACCURACY OR COMPLETENESS OF THE INFORMATION, TEXT, GRAPHICS OR OTHER ITEMS CONTAINED WITHIN THESE MATERIALS. SKYWORKS SHALL NOT BE LIABLE FOR ANY DAMAGES, INCLUDING BUT NOT LIMITED TO ANY SPECIAL, INDIRECT, INCIDENTAL, STATUTORY, OR CONSEQUENTIAL DAMAGES, INCLUDING WITHOUT LIMITATION, LOST REVENUES OR LOST PROFITS THAT MAY RESULT FROM THE USE OF THE MATERIALS OR INFORMATION, WHETHER OR NOT THE RECIPIENT OF MATERIALS HAS BEEN ADVISED OF THE POSSIBILITY OF SUCH DAMAGE.

Skyworks products are not intended for use in medical, lifesaving or life-sustaining applications, or other equipment in which the failure of the Skyworks products could lead to personal injury, death, physical or environmental damage. Skyworks customers using or selling Skyworks products for use in such applications do so at their own risk and agree to fully indemnify Skyworks for any damages resulting from such improper use or sale.

Customers are responsible for their products and applications using Skyworks products, which may deviate from published specifications as a result of design defects, errors, or operation of products outside of published parameters or design specifications. Customers should include design and operating safeguards to minimize these and other risks. Skyworks assumes no liability for applications assistance, customer product design, or damage to any equipment resulting from the use of Skyworks products outside of stated published specifications or parameters.

Skyworks, the Skyworks symbol, and "Breakthrough Simplicity" are trademarks or registered trademarks of Skyworks Solutions, Inc., in the United States and other countries. Third-party brands and names are for identification purposes only, and are the property of their respective owners. Additional information, including relevant terms and conditions, posted at [www.skyworksinc.com](http://www.skyworksinc.com), are incorporated by reference.